



MMM Group

FRIOCELL[®] EVO

Incubator with Forced Air Circulation
and Active Cooling



Innovative Heat Technology

MMM. Protecting human health.

Tradition, Quality, Innovation

Since its establishment in 1921, BMT Medical Technology s.r.o., the traditional manufacturer of medical and laboratory technology, has been gradually transformed from a small regional company to an international corporation.

In 1992, it became a member of the European MMM Group which has been operating on the world markets since 1954 as an important supplier of systems for the health care industry, science and research. With its comprehensive offer of products and services, sterilization and disinfection devices for hospitals, scientific institutes, laboratories and pharmaceutical industry, MMM Group has established itself as an outstanding quality and innovations producer on the global markets.

The knowledge and experience gained during the implementations of individual supplies for our customers all over the world, and the technical innovations have been permanently and positively influencing the development, construction and production of our devices. High level of our work has also been confirmed by the number of patents and industrial designs as well as an easy implementation of individual device adjustments.

MMM Group
– excellence in medical and laboratory technology.

Basic Characteristics

Volume: 55, 111, 222, 404, 707, 1212 litres
Working temperature: 0°C up to 100°C range up to 70°C for the volume of 1212 l
 FC EVO as optional equipment up to -20°C
 FC EVO as optional equipment of chamber decontamination up to 160°C (except for the 1212 litres volume)
Refrigerant: R513a, (or R134a) for -20 °C R449a
CO₂ concentration: 0,2% up to 20% (optional equipment)
Inner glass door
Interior: stainless steel, mat. No. 1.4301 (AISI 304)

FRIOCELL® EVO

Precise and Energy-Saving Incubator with Active Cooling

The device FRIOCELL® provides time and space-precision tempering of materials in the field of bio-technologies, botany, zoology, food processing, cosmetics, chemistry, etc. A unique cooling system offers exact and economic simulation of selected natural processes; it reduces evaporation of samples and allows extremely low temperature conditions regeneration times. In case of optional equipment buying, the device offers regulation of CO₂ respectively other gases concentration or space-homogenous lighting in the field of visible or UV light with adjustable intensity and possibility of intensity measuring using special probes. Thanks to the unique combination, the device offers a wide range of possible applications to users.

Maximum refrigerant safety without location restrictions

The CLIMACELL® and FRIOCELL® models now use an innovative refrigerant that meets the highest safety standards according to EN 378-1+A1 - it is non-flammable, does not form an explosive mixture in the event of a leak and is also non-toxic. Thanks to its classification in A1 safety group, the risk to the operator and the environment is minimal. This change brings the significant advantage of completely free placement of the device without the need for special technical modifications to the space. Our laboratory equipment thus offers not only top performance and precise temperature control, but also a new higher level of safety and lower operating requirements - the ideal choice for modern and responsible laboratories.

Meeting the requirements of regulations 2014/35/EU, 2014/30/EU, ICH 279/95 Option 2, FDA 21 Part 11, 2011/65/EU, 517/2014/EU, 573/2024/EU.



Applications



Pharmaceutical Industry

Tests of photo stability according to ICH 279/95 Option 2, quality tests of pharmaceutical raw materials



Cosmetic Industry

Durability testing, testing of cosmetic products or primary materials stability



Plastics Industry

Temperature stabilisation of reference samples



General and Applied Industry (research field)

E.g. cultivation of tissue cultures – human or animal ones



Food Industry

Tests of food products expiration date



Beverage Industry

Rapid beer quality test (12h/5°C+12h/40°C)



Water Management

Testing of water quality in municipal water preparing plants (BSK5 at 5°C)

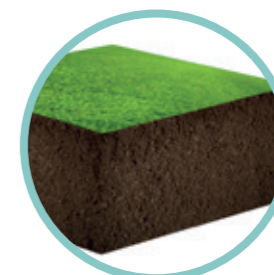

Agriculture

Enzymatic reactions and microbiologic activities in soils



Zoology

Simulation of conditions for living organisms research – cultivation of fish eggs, cultivation of insects development stages



Botany

Studies of germination, green plants growing for further research



Paper Industry

Long-term testing of paper quality



Paints and Varnishes Industry

Paints stability testing – resistance to UV radiation

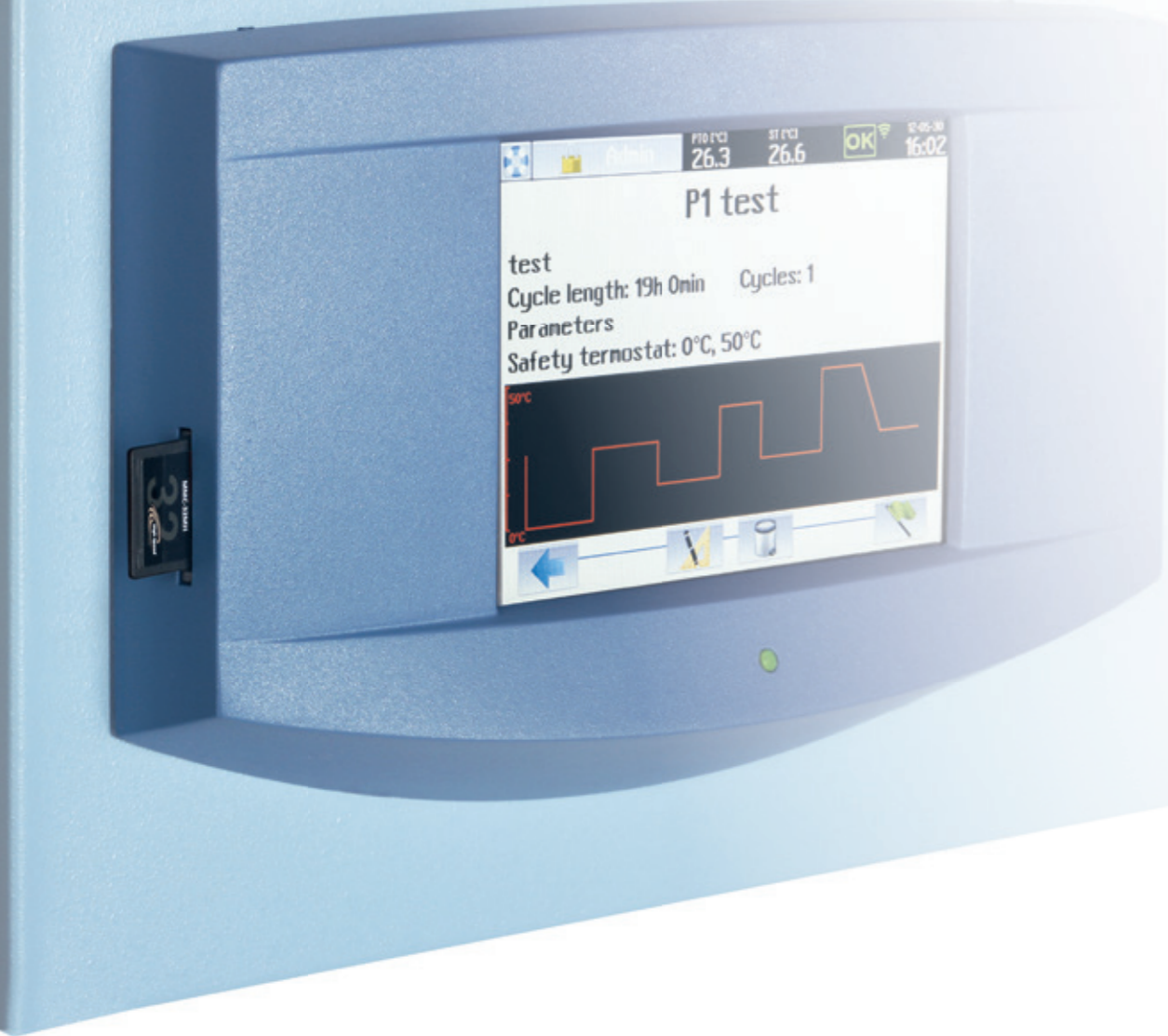

The New Control System Offers

- 5.7 inch (14.5 cm) touch screen display
- Microprocessor Fuzzy logic process control
- Intuitive control via colour icons
- Graphic configuration of a new program
- Transparent displaying of data course at the cycle
- Protective thermostat class 3
- Acoustic and visual alarm
- Multi-level users administration (corresponding to FDA 21 Part 11)
- Keyboard lock against unauthorised handling
- Data encryption and non-manipulability (corresponding to FDA 21 Part 11)
- Up to 100 programs and up to 100 segments for each program
- Yearly data logger in graphic and numeric form
- On-line or off-line data export
- Prepared service programs for fast diagnostics of faults
- Easy service diagnostics including remote access
- Multi-language communication
- Direct printing of protocols in PDF format via Warmcomm 4.0
- Easy user configuration of the device
- SD memory card, USB Host and RS 232 standardly included
- USB device or Ethernet interface with own IP address for remote data transfer, control and diagnostics (optional equipment)
- Programming of ramps, real time and cycling
- Fan setting 0–100%
- Main ON/OFF switch for security reasons
- Device state LED indicator

Connectivity

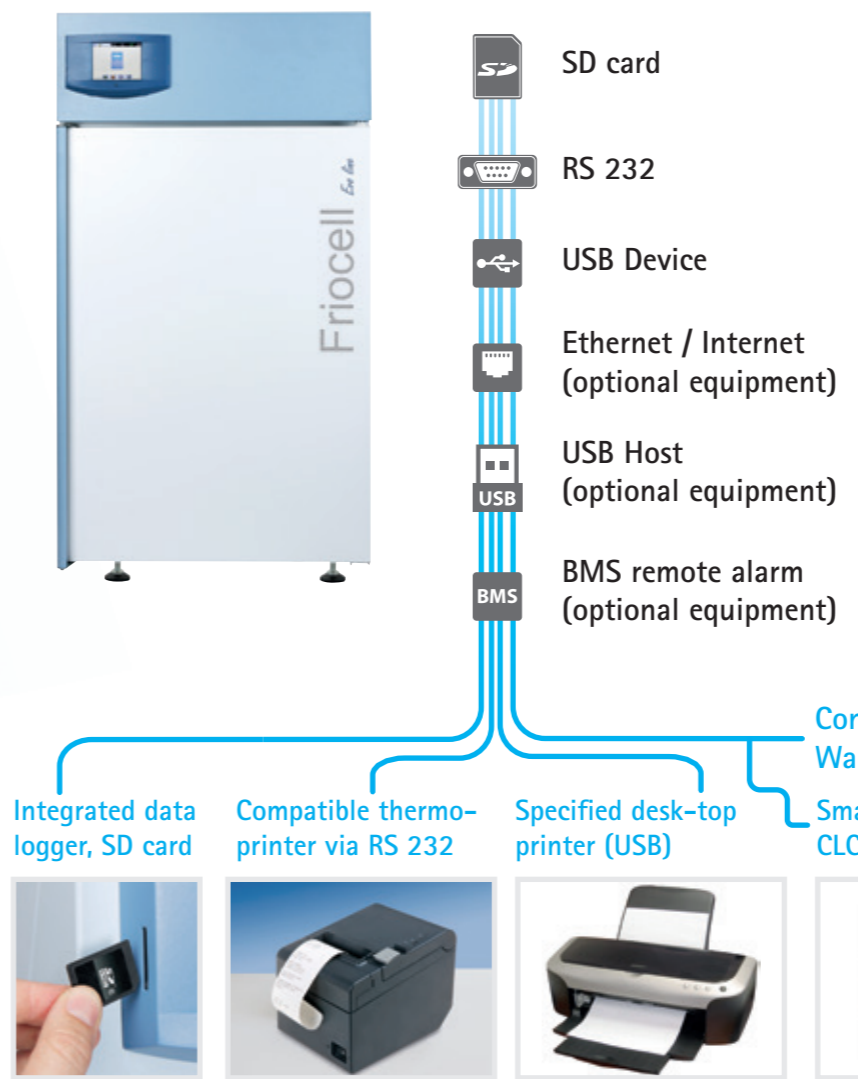

Data Outputs

Thanks to the most up-to-date components of electronic, the device FRIOCELL® EVO does not have any data peripherals connection limit. The basic configuration contains traditional and reliable RS 232, USB Device and the SD card as the data carrier. There is also available the USB Host for bi-directional USB communication and for remote connection there is the Ethernet (RJ 45) connection. Proper IP address allows easy connection to PC or selected printer, respectively other usual data periphery (Smartphone, Netbook, etc.). Thanks to the open platform and adjusted data format it is also possible to configure remote connection and to work with on-line data in remote mode (internet).



WarmComm 4.0

Universal data administration for BMT/MMM heating technology devices



- Compatible with EVO line and ECO line devices
- Backward compatible with older heating technology series (Standard, Comfort – all except CO2CELL)
- Stable platform of the SQL library
- User-friendly environment
- Connection via Ethernet, RS 232 and USB
- Two-way communication – data monitoring and device control
- Client-Server architecture
- Three levels of the program depending on client's requirements (Basic-Professional-FDA)
- In compliance with FDA CFR 21 Part 11 (version F)
- Web support, on-line updating
- Protected licence policy
- Compatible with MS Windows XP/7/8/10 operating systems
- Validation documentation IQ/OQ



Comfort Machine with Superior Parameters

MMM Group offers traditionally fully ranged size of the cabinet, from personal size 55 litres, up to new size 1212 litres, with the best ratio cost/performance. Patented vertical air flow with preheating chamber and asymmetrically perforated panels ensure the well proven vertical spiralled air flow with the best spatial homogeneity.

Deep experience of the factory engineers and many years of careful development help with sophisticated Fuzzy logic control system. By means of the Fuzzy logic are continually evaluated the current process conditions as size of chamber, set parameters, quantity of the samples inside and herewith optimizing heating, cooling and steaming performance.

Practical large and popular door handle, robust wheels with brakes and 220° (with exception of size 707, 1212) openable main door(s) contributes to high user friendly character of the device. Light grey with light blue device colours highlighted by dark blue smiley control panel cause a pleasant feeling of harmony in the user every morning

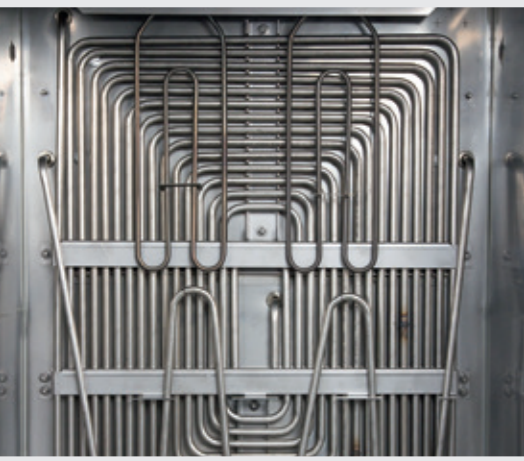
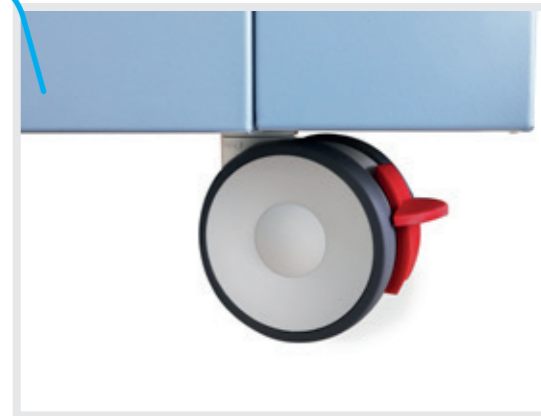
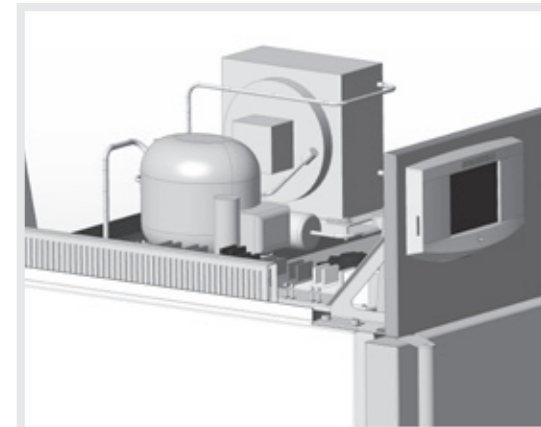
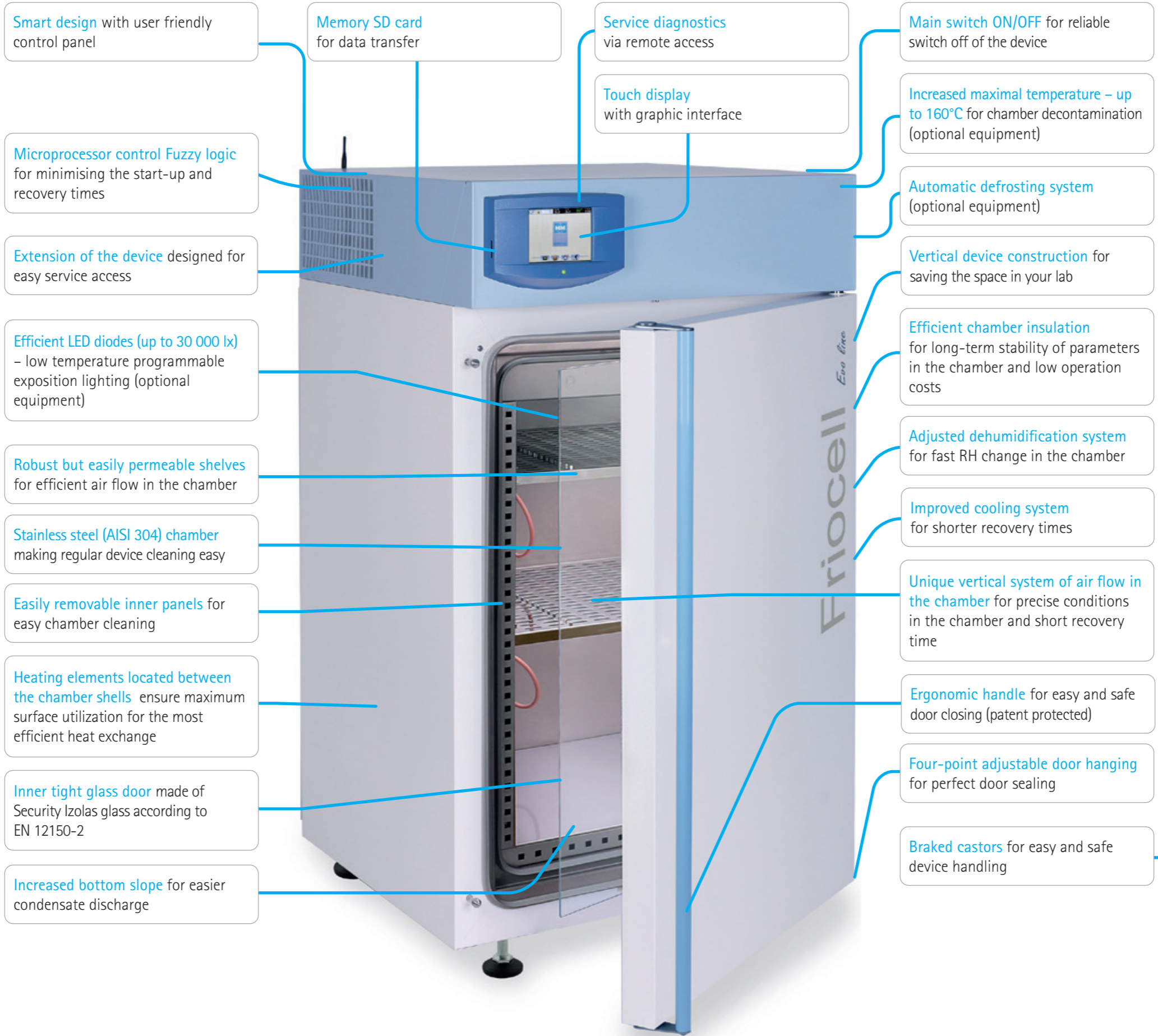

Programmable Exposure Lighting

New generation of the FRIOCELL® EVO device offers wide possibilities of selected lighting use. The variability of placement, selection of light sources, user friendliness and possibility of fluent intensity control meet even the most demanding requirements towards applications with exposure lighting.

Fluorescent Tubes in Doors

Traditional placement of the light case with new design and increased intensity of lighting (up to 36 000 lx). Exposure of the whole cross-section of the chamber with the lowest purchase costs and minimal influence on conditions in the chamber. Program-controlled switching on and off of the lighting for FRIOCELL® ECO. Program-controlled regulation of intensity within the range of 10-100% in increments of 1%, which can be completed with intensity measuring for FRIOCELL® EVO. Suitable for industrial simulation of materials ageing or undemanding processes of growth simulations. Simulation of day and night conditions. Available for FRIOCELL® ECO + FRIOCELL® EVO.

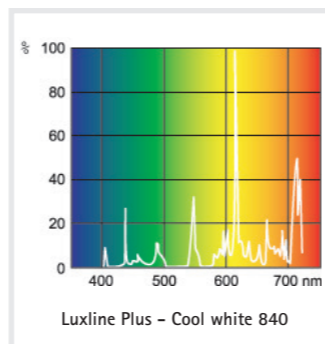

Fluorescent Tubes in Shelves

A vertical source of up to three light cases with direct lighting and variable height of lighting. Even lighting of the whole shelf and optimal use of the chamber volume for the area size lighting. Efficient balancing of temperature emissions thanks to perforation of cases and precise regulation of conditions in the chamber even under full lighting. Maximal intensity 23 000 lx (12 cm below the source). Program-controlled switching on and off of the lighting for FRIOCELL® ECO. Program-controlled regulation of intensity within the range of 10-100% in increments of 1%, which can be completed with intensity measuring for FRIOCELL® EVO. Typical for tests of photo-stability or basic growth simulations in botany. Simulation of day and night conditions. Available for FRIOCELL® ECO + FRIOCELL® EVO. Different colours of the light source.

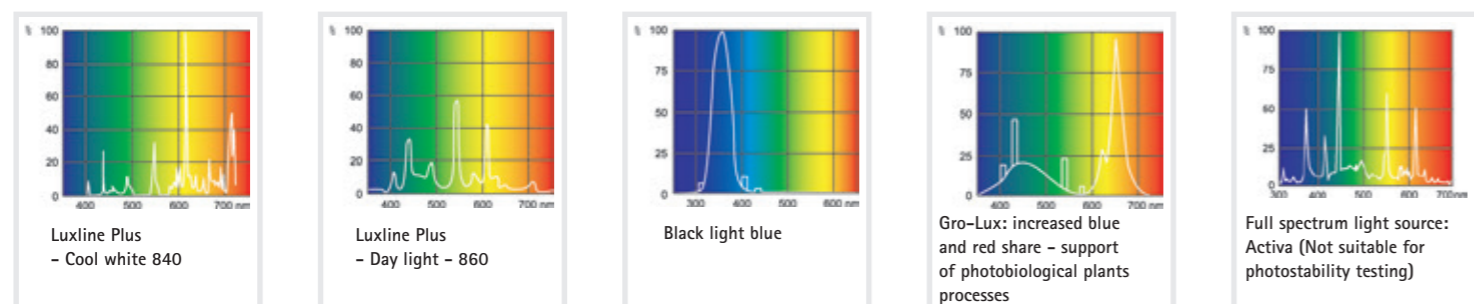

LED Lighting in the Door

Economic solution of white exposure LED lighting with higher intensity (up to 21 000 lx). Exposure of the whole cross-section of the chamber with low temperature emissions. Program-controlled switching on and off of the lighting for FRIOCELL® ECO. Program-controlled regulation of intensity within the range of 10-100% in increments of 1%, which can be completed with intensity measuring for FRIOCELL® EVO. Suitable for industrial testing with high demands towards intensity. Simulation of day and night conditions. May be completed with intensity measuring. Available for FRIOCELL® ECO + FRIOCELL® EVO.

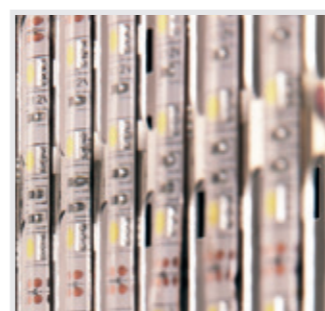

White LED Lighting in Shelves

Precise horizontal lighting with white or colour LED lighting with maximal intensity (up to 30 000 lx), low temperature emissions of the light source, variability of enlightened cases placement. Program-controlled switching on and off of the lighting for FRIOCELL® ECO. Program-controlled regulation of intensity within the range of 10-100% in increments of 1%, which can be completed with intensity measuring for FRIOCELL® EVO. It is suitable for industrial use or use in botany. Maximal use of enlightened surface of shelves in relation to the chamber volume. Simulation of day and night conditions. May be completed with intensity measuring. Available for FRIOCELL® ECO + FRIOCELL® EVO.

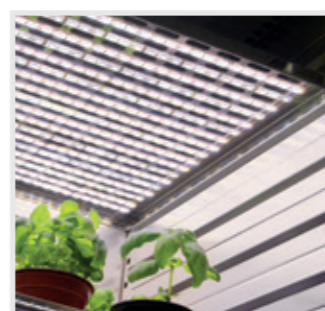

Configuration for typical applications



Based on our experience we offer optimal configurations for selected applications, typical for FRIOCELL®.



Botany

Studies of germination, green plants growing for further research



Pharmaceutical Industry

Tests of photo stability according to ICH 279/95 Option 2, quality tests of pharmaceutical raw materials

Growth Chamber - White



Exact growth chamber with variable growth height and full-spectrum fluently controllable LED lighting.

- Base used FRIOCELL® EVO
- Chamber sizes 111, 222, 404, 707, 1212
- Up to four floors with LED lighting
- Up to 3,4m² of lighted surface
- Full-spectrum stable white LED lighting with fluent intensity regulation (step 1%)
- Maximal intensity up to 330 $\mu\text{mol}/\text{m}^2/\text{s}^*$
- Maximal growth height up to 1300 mm
- Automatic defrosting
- CO₂ regulation (option)

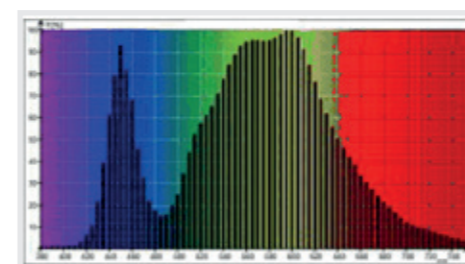

Growth Chamber - Spectral



Growth chamber optimising high lighting intensity with optimal colour spectrum of LED source for photosynthesis and low power consumption.

- Base used FRIOCELL® EVO
- Chamber sizes 111, 222, 404, 707, 1212
- Up to four floors with LED lighting
- Up to 3,4m² of lighted surface
- Diversified blue-red-fared (2:2:1) LED source optimised for photosynthesis with fluent regulation of individual light components
- Maximal intensity up to 311 $\mu\text{mol}/\text{m}^2/\text{s}^*$
- Maximal growth height up to 1300 mm
- Automatic defrosting
- CO₂ regulation (option)

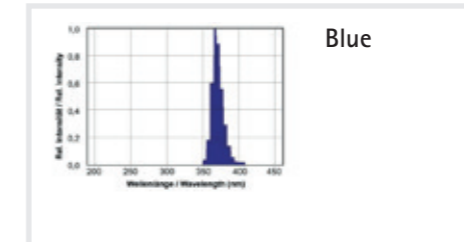
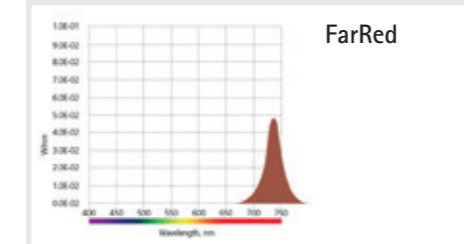
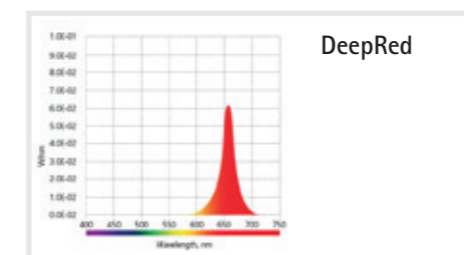
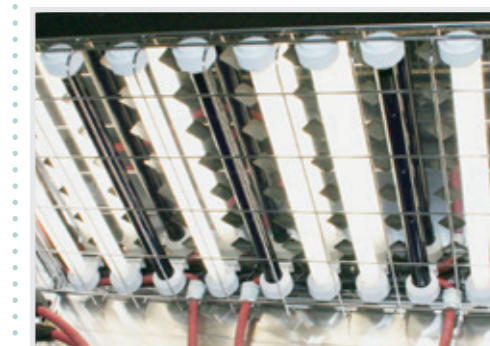

Photo-stable Chamber



Chamber with combined or separated VIS-UV source of light with independent control and automatic assessment of photo stability test.

- Base used FRIOCELL® EVO
- Chamber sizes 111, 222, 404, 707, 1212
- Three combinable VIS-UV lighted shelves or two VIS + one UV lighted Shelf
- Automatic control of process duration
- Automatic assessment of exposure dose (with option VIS and UV measuring)
- High intensity of lighting - up to 20,000 LUX and 2,56 mW/cm²/s-1*
- Short exposure times
- High light homogeneity for equal lighting of all the samples
- Printing of protocols for individual exposure doses with confirmation
- Automatic defrosting



*) measured 12 cm below the Shelf

Accessories Included

Each FRIOCELL® EVO is supplied with standard equipment which does not have to be additionally ordered and it makes a standard part of delivery:



Optional Equipment

Thanks to modular construction of our devices even FRIOCELL® EVO may be additionally equipped according to your preferences with many additional options. FRIOCELL® EVO may then serve as a chamber for testing of photo-stability, light simulation of day and night, processes with CO₂ control, hot-air decontamination, etc.

- | | | |
|----------------------------------|--------------------------------------|--|
| 1. Hot-air decontamination 160°C | 8. CO ₂ control | 15. Programmable inner socket |
| 2. Additional cooling -20°C | 9. Software WarmComm 4,0 | 16. External printer |
| 3. Flexible temperature sensors | 10. Data module USB device, Ethernet | 17. Multi-point temp. / humidity measuring |
| 4. LED light shelves | 11. Mechanic door lock | 18. IQ/OQ protocols |
| 5. Exposure lighting in doors | 12. Electromagnetic door lock | |
| 6. Light sensors of exposure | 13. Trays or shelves | |
| 7. Defrosting system | 14. Access port Ø 25, 50, 100 mm | |



Technical Parameters



FRIOCELL® EVO (FC EVO)		55	111	222	404	707	1212		
Technical data Internal space - chamber, stainless steel DIN 1.4301 (AISI 304)	volume	Approx. l	54	110	219	404	704	1408	
	width	mm	400	540	540	540	940	3x540 (1905)	
	height	mm	355	535	765	1415	1415	1415	
	depth	mm	380	380	530	530	530	530	
Volume of the steam space		Approx. l	91	167	305	530	878	1753	
External dimensions (including door, Handle H and caster C)	width	mm	640	780	780	1100	1500	2530	
	height	mm	940H	1187H	1450H	1890C	1890C	1921C	
	depth	mm	755	755	885	885	885	898	
Package - dimensions (three-layers carton)	width	Approx. mm	990	992	1120	1332	1682	2742	
	height (incl. palette)	Approx. mm	1300	1650	1746	2200	2190	2240	
	depth	Approx. mm	830	954	952	1062	1064	1137	
Weight	nett	kg	95/105**	110/120**	143/153**	240/250**	280/290**	519/545**	
	brutt (carton)	kg	180/190**	220/230**	263/273**	390/400**	500/510**	839/865**	
Shelves of stainless steel *)	shelves	max. No.	5	7	10	19	19	3x19	
	standard equipment	pcs. included	2	2	2	2	2	6	
	min. distance between shelves	mm	70	70	70	70	70	70	
	Storage area (w x d)	mm	380x335	520x335	520x485	520x485	920x485	520x485	
Maximal load *)	per 1 tray	kg/screen	20	20	30	30	50	30	
	for a shelf	kg/shelf	20	20	30	30	20	30	
	total inside of device	kg/case	50	50	70	100	130	300	
Number of outer metal doors	psc.	1	1	1	1	2	3		
Number of inner glass doors	psc.	1	1	1	1	2	3		
Electrical data	max. power requirement	W	700/850**	1000/1150**	1150/1300**	1700/1700**	2000/2050** ***	2500/3300**	
	mains 50/60 Hz	V	115/230	115/230	115/230	115/230	115/230	115/230	
IP Code		IP20	IP20	IP20	IP20	IP20	IP20		
Temperature data	from 0°C	to °C	100 (decontamination 160°C)					70	
	from -20°C	to °C	100 (decontamination 160°C)					70	
Temperature accuracy	in space at 10°C	Approx. (±) °C	<0,5	<0,5	<0,5	<1	<1	<0,6	
	in space at 37°C	Approx. (±) °C	<0,5	<0,5	<0,5	<1	<1	<0,5	
	in time	Approx. (±) °C	<0,2	<0,2	<0,2	<0,3	<0,4	<0,2	
Heating/up time to 37°C from the ambient temperature	min	<11	<11	<11	<13	<13	<30		
Cooling/down time from 22°C to 10°C	min	<21/<11**	<21/<11**	<17/<14**	<19/<11**	<21/<22**	<21		
Recovery time after 30 s of door opening according to DIN 12 880	at 37°C	min	<5	<5	<2	<2	6	10	
	at 50°C	min	<6	<6	<3	<4	6	10	
Heat emission	at 37°C	Approx. W	55	70	63	123	148	200	
Complete device noise level		dB	45/50**	46/52**	50/56**	56/58**	58/65**	60	
CO ₂ concentration		%	0,1-20					-	0,1-20
Required pressure CO ₂		bar/psi	0,3-0,7/5-10**					-	0,3-0,7/5-10**

Note: All technical data are related to 22°C ambient temperature.

*) Approx. 50% of the tray area can be filled in a way a uniform air circulation is enabled inside the chamber.

***) Value at cooling up to -20°C.

***) max. power requirement with decontamination 2500 W

The values may differ depending on specific charge and media parameters.

Change in the design and make reserved.



Make Acquaintance With Our Further Offers ...

Unique Line... Cell



Designation	Type marking	Laboratory case type	ECO line		Natural air circulation	Forced air circulation	Temperature range in °C (Optional equipment)	Volume 22 (l)	Volume 50 (l)	Volume 55 (l)	Volume 111 (l)	Volume 190 (l)	Volume 222 (l)	Volume 404 (l)	Volume 707 (l)	Volume 1212 (l)	
			ECO line	EVO line													
drying, tempering, sterilization	ECOCELL®	drying oven	•		•		5*-250/300	•		•	•		•	•	•		
	DUROCELL	drying oven with protective layer of inner space EPOLON	•		•		5*-125	•		•	•		•				
	VENTICELL®	drying oven	•			•	10*-250/300	•		•	•		•	•	•	•	•
	STERICELL® ***	hot-air sterilizer	•			•	10*-250	•		•	•		•	•			
	VACUCELL®	drying oven with vacuum	•				5*-250/300	•		•	•						
incubation	INCUCELL®	incubator / biological thermostat	•		•		5-100	•		•	•		•	•	•	•	•
	INCUCELL® V	incubator / biological thermostat	•			•	10-100	•		•	•		•	•	•	•	•
	FRIOCELL®	incubator with cooling	•			•	0-100 (-20)			•	•		•	•	•	•	•
	CLIMACELL®	incubator with cooling and controlled humidity	•			•	0-100 (-20)			•	•		•	•	•	•	•
	CO2CELL**	incubator with CO ₂ atmosphere		•	•		5*-60		•			•					

* above the exterior temperature

** manufacturer MMM Medcenter Einrichtungen GmbH, Semmlweisstrasse 6, D-82152 Planegg / Munich, tel.:+49 89 89 92 26 20, e-mail: medcenter@mmmgroup.com

*** the STERICELL® line also meets European Directive 2017/745 (MDR) for medical devices

Make acquaintance with our further offers...



VENTICELL® IL depyrogeneration cabinets



Steam sterilizers



Steam sterilizers



Hot-air sterilizers



youtube.com/bmtbrno



facebook.com/bmt.cz



MMM Medcenter Einrichtungen GmbH, Semmlweisstrasse 6, D-82152 Planegg / München
Tel.: +49 89 8992 2620, Fax.: +49 89 8992 2630, E-mail: medcenter@mmm-medcenter.de, www.mmm-medcenter.de